

A Comparison of Mulpin VS Embedded Passive Technology

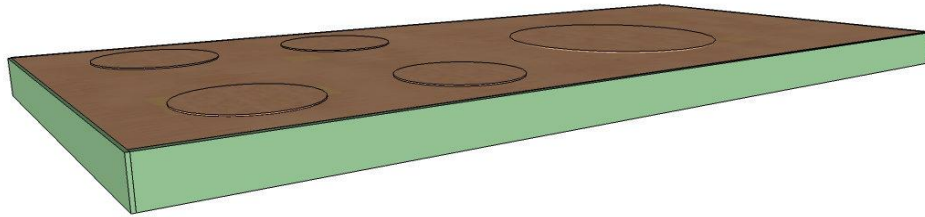
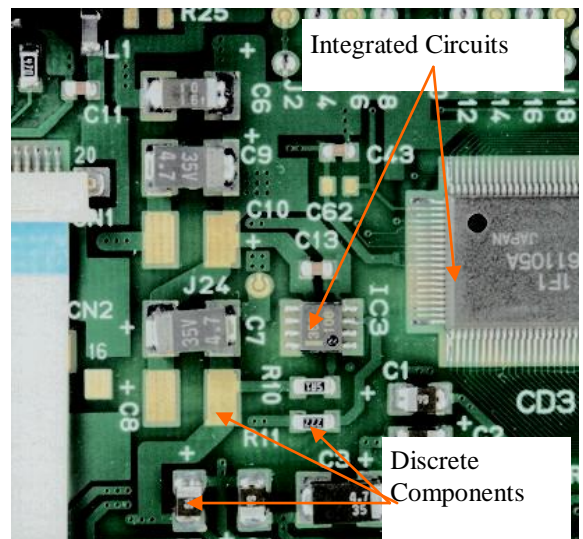

ILLUSTRATION OF A MULPIN PCB WITH EMBEDDED PASSIVE AND ACTIVE COMPONENTS

The technology behind modern Printed Circuit Boards abbreviated as PCBs has been advancing steadily since the 1960s. The recent development in high end PCBs has been to bury certain passive components within the structure of the PCB. This has only relatively recently become feasible because of the ever shrinking size of electronic components since the introduction of portable devices such as mobile/cell telephones, which have more computing power than an entire desk top computer ten years ago.

Why embed the components?

Embedded components have advantages over SMD because they are naturally screened from high frequency radio emissions (RFI or EMI). They can also be smaller than current SMD components. Both embedded and Mulpin components have these advantages, but Mulpin components have many more advantages and none of the disadvantages which can be seen below.



What is a PCB?

A PCB is simply a method of connecting up electronic components to make up a full circuit such as a mobile/cell telephone, graphics tablet or radio just to name a few. Many different electronic products use some of the common mass produced off the shelf electronic components but they are connected in different ways to make up different PCBs. A typical SMD PCB is shown to the right above.

Current state of the art. The current state of the art is what is called SMD which is short for Surface Mounted Devices. SMD technology as the name suggests has all of the electronic components attached with solder to the top surface of a PCB. The components are all mass produced in the millions and are discrete in nature and interconnect with copper traces between the components to make up a complete circuit. To achieve these connections the PCB may have many layers so that the copper traces can go to their respectful destinations without short circuits with other traces going elsewhere. Small connections called vias connect from one layer of the PCB to others to achieve the required connections mentioned above.

Production of an SMD PCB.

PCBs using SMD parts are all produced in the same way. Once the PCBs are manufactured, drilled, laminated (layered with adhesive) and with no components on them, they are placed in a pick and place machine which takes the mass produced components mentioned above which are on reels and places them onto the top surface of the PCBs. This is a quick process and the PCBs go to a heating oven which solders the components in place. When the solder cools the PCBs are removed and stacked for assembly into the product for which they are designed.

Production of Embedded Passive Component PCBs: Non Mulpin

Embedded Components are literally grown onto a PCB and each requires several stages of manufacture and is made by a series of electroplating, etching and deposition of materials. Capacitors are formed in a different way to resistors and this is why the resistors must be laid down on a different layer of the PCB to that of the capacitors, see Figure 8. The processes are also slow and this would be a serious bottleneck in the production of large volume items such as mobile telephones and domestic electronics.

The production of these passive embedded components requires large changes to the currently used PCB manufacturing methods. The object is to embed passive components only. This is because it is impractical to fabricate active semiconductor components in this manner.

The embedded passive components when completed are buried under additional layers of the PCB fibre glass resin and copper and cannot be removed for repair. The active components must go on top of the PCB, which incidentally removes much of the RFI protection offered by embedding the passive components in the first place. ***For RFI to be effective all components must be embedded, especially active components.***

Production of Embedded Mulpin Component PCBs Passive and Active.

Mulpin embedded components are very similar in their treatment to that of SMD components but most have their connections on more than one PCB layer. Mulpin components are placed into an opening drilled into the PCB. If the component has many connections such as an integrated circuit (active component) like that shown in Figure 1 below, the hole in the PCB will be from the top down to the lowest layer occupied by the component. Since the holes in a PCB are drilled by stacking the same layer of many PCBs and drilled in one operation there is no added cost associated with this process.

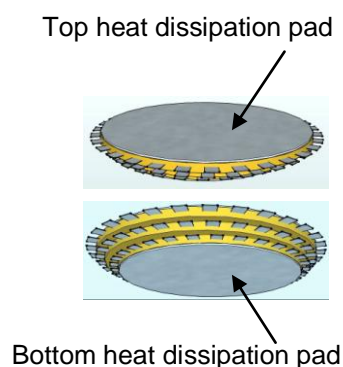

Figure 1: at left are top and bottom views of a Mulpin Integrated circuit with 96 connections over three PCB layers. Notice the top and bottom heat dissipation pads.

Simple passive components like resistors and capacitors like those shown in Figure 2 are treated in the same way. Once the layers are drilled, and laminated the PCB is ready for the components. Thus there are no extra processes needed to produce the PCB. The Mulpin Components both active and passive are treated in exactly the same way and are placed into the PCB using the same pick and place machine as is used in current SMD PCBs. Thus there is no added cost here in this process. The PCBs with their components are then sent to the same heating oven as for SMD PCBs. Thus there is no added cost here either. The PCBs are now stacked for assembly into the final product, the same as for SMD PCBs.

This illustrates that Mulpin is more cost effective as no change to the manufacturing process of the PCB or its assembly is required. With embedded passives the manufacturing process requires a complete factory equipment refit and skills in the use of the equipment.

Glossary of Terms.

Surface Mounted Devices (SMD). Electronic components which are mounted on the top surface of a PCB.

Discrete Components. Electronic components which are a single part such as a transistor, resistor capacitor etc which is not enclosed with other components.

Integrated Component (Integrated Circuit). A component such as a logic gate, memory device, computer chip and many others which has more than one component and often a million or more components integrated into one package.

Embedded Components. Electronic Components which are hidden within the PCB structure and thus cannot be seen from outside of the PCB.

Passive Components. These components do not change their characteristics with applied electrical signals. Components like capacitors and resistors are in this category.

Active Components: These components almost always contain semiconductors and normally will modify an electrical signal by some pre-determined electrical law.

Mulpin Passive Components

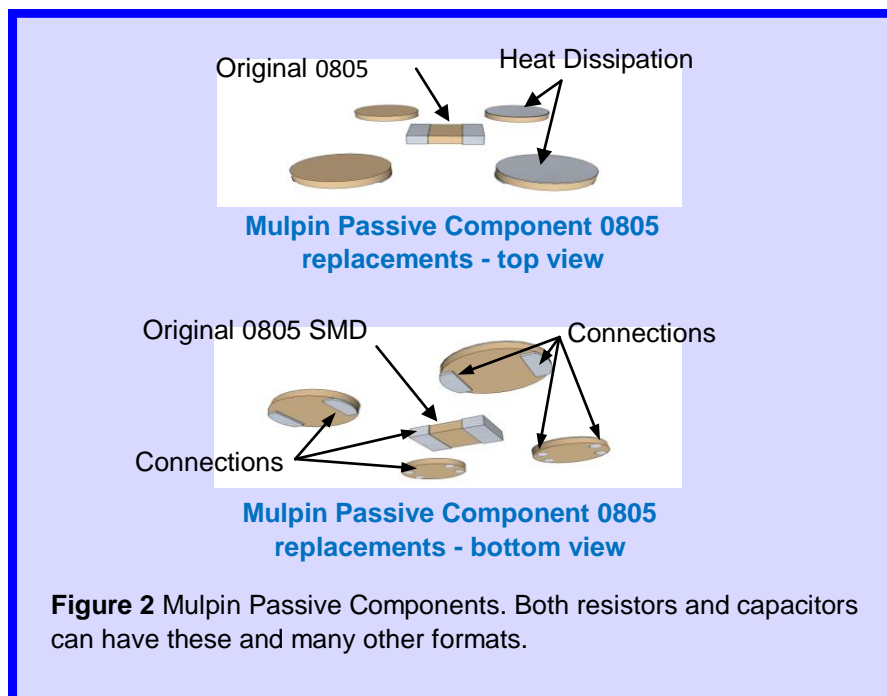

Mulpin Advantages over other embedded passives.

Smaller PCB area which is inversely proportional to number of layers used. For instance, a four layer PCB can have $\frac{1}{4}$ of the area due to the smaller active component area. This is a considerably larger improvement over other embedded component methods. See Figure 9 for an example to scale of a typical active Mulpin Component shown against an equivalent SMD device.

More boards per panel in manufacturing than either SMD or other embedded components.

Faster production due to the use of standard production methods, No bottlenecks in the production process.

Mulpin passive components are embedded and use standard SMD production methods, which require no additional production stages.

Mulpin Active components are the only embedded active technology available, and uses standard SMD production methods, which require no additional production stages or equipment.

Mulpin passive embedded devices can occupy whichever PCB layers are desired, even multiple layers giving greater circuit flexibility than other embedded technologies.

Mulpin PCBs have much lower cost due to higher production speed than other embedded technologies.

Mulpin PCBs have lower cost due the use of current production facilities.

Mulpin PCBs have lower cost due to no modifications to current production facilities.

Mulpin PCBs have lower costs in that no added heat sink requirement or labour costs where the top copper surface of the PCB offers sufficient heat dissipation.

Mulpin PCBs have lower costs where an additional heat sink is needed; a single heat sink can cover many embedded Mulpin components, saving labour and time.

High routing density possible due to the multi-layer nature of active embedded components.

Mulpin faster operating speed than SMD circuits.

Extended PCB life and reliability long term due to the excellent heat dissipation characteristic of Mulpin PCBs, and the extreme vibration proofing of Mulpin PCBs.

Mulpin Passive Components are more versatile as they can be self screening, thus reducing unwanted inter-circuit coupling when this is required.

Much better heat dissipation possible with Mulpin passive components due to components being in direct contact with the top surface of the PCB when needed. Other embedded components must pass their heat through the PCB laminate before exiting which is less efficient resulting in higher operating temperatures

Temperature cycling reliability is improved due to the ability to sink heat to the PCB ground plane, a big advantage due to lower operating temperature, thus lower expansion and contraction during the life of the PCB.

Mulpin requires no layer stacking of components as is the case for other embedded components, which means that components can be placed on the best layer or layers for best circuit performance. Figure 8 shows an example of layer stacking in a non Mulpin embedded passive component PCB.

Mulpin components can be either horizontal or vertically mounted depending on component design. Only Mulpin Components are capable of this.

Components are fitted through an opening in the PCB and can thus be changed if needed. Thus rework or repair is a simple matter.

Much better performance in the area of EMI and RFI and EMP and stray inductance because all of the components including the integrated circuits are embedded. (See “proof of Concept” video exposing a Mulpin PCB to one million volts from a Tesla Coil and 800 watts from a Microwave oven). www.mulpin.com

Extremely rugged and vibration proof as components are held fast on multiple layers.

Mulpin PCBs are also water proof and dust proof due to self screening (see fig 5)

Computer modeling is mandatory for other embedded technology because the design once implemented cannot be changed. This is not true of Mulpin designs. This enables unusual circuits to be built with confidence.

Both Mulpin Technology and embedded passive technology offer less interconnecting trace length on the PCB layouts due to connections from integrated circuits emerging on best PCB layer for the connection (fewer vias).

Dual Use of some Mulpin components. Some packages can be used as either SMD or in Mulpin configuration. A circuit can be developed using the component as SMD, then buried for secure production as Mulpin parts. (See Figure 10) No other embedded or SMD components can achieve this.

Excellent security against reverse engineering, due to inaccessible connections of components designed for it.

Weight saving due to the smaller Mulpin PCBs which have rugged construction requiring less external mechanical protection.

Weight saving due to Mulpin PCBs not requiring external RF shielding, whilst other embedded technology still requires external shielding because the active components which are much more sensitive to RFI than passive ones, are still exposed to RFI /EMI whereas *Mulpin components are all embedded.*

Mulpin components can each be shielded from one another. This is not possible with either SMD or other embedded components.

Disadvantages of other embedded Passive Technology.

“The following information link on ‘Embedded Passives’ was made by Jason Ferguson , NSWC Crane. Nov 10 2010.

Manufacturability <http://ewh.ieee.org/soc/cpmt/presentations/cpmt1011a.pdf>

page 56

PCB manufacturers will not want to invest in new equipment without a large return on their investment because an entire new plant will be needed for the manufacture of current embedded passive technology in PCBs.

PCB manufacturers will have to learn :-

How to scale resistors.

How to panelize and assign nomenclature to PCB layers.

Handling thin core materials that are less than 16um thick.

Laser trimming of resistors.

New process chemistries.

Other Disadvantages

Not as Robust as Mulpin PCBs in areas of mechanical rigidity.

Vulnerable To RFI, EMI and EMP.

Production Bottle necks.

Larger PCB area than Mulpin PCBs

Slower turn around because of the processes used in making the embedded passives.

Cannot embed active components.

Less flexibility due to the need for component layer stacking.

Higher cost due to slow turnaround.

Higher cost due to the requirement of new production facilities.

Heat dissipation more difficult because heat buildup must escape by first passing through the PCB substrate.

Higher cost to fit external heat sink.

Cannot use one heat sink for an entire PCB where multiple components require a heat sink.

Shorter PCB life expectancy in some instances due to greater temperature fluctuations than would occur with an equivalent Mulpin PCB.

Passive components are not self screening (cannot be).

Limited component and thus circuit flexibility as the components can only be mounted on one layer of the PCB.

Passive components on the PCB are unserviceable.

Special treatment required to make PCBs water proof, and dust proof.

Extra weight needed to make PCBs water proof and dust proof.

No dual use components to assist in design possible. See text above Figure 10.

Less secure against reverse engineering due to the requirement that active components and hence their pins are accessible.

Extra weight required for external RF shielding.

An example of current Embedded Passives

<http://ewh.ieee.org/soc/cpmt/presentations/cpmt1011a.pdf> (Page 27)

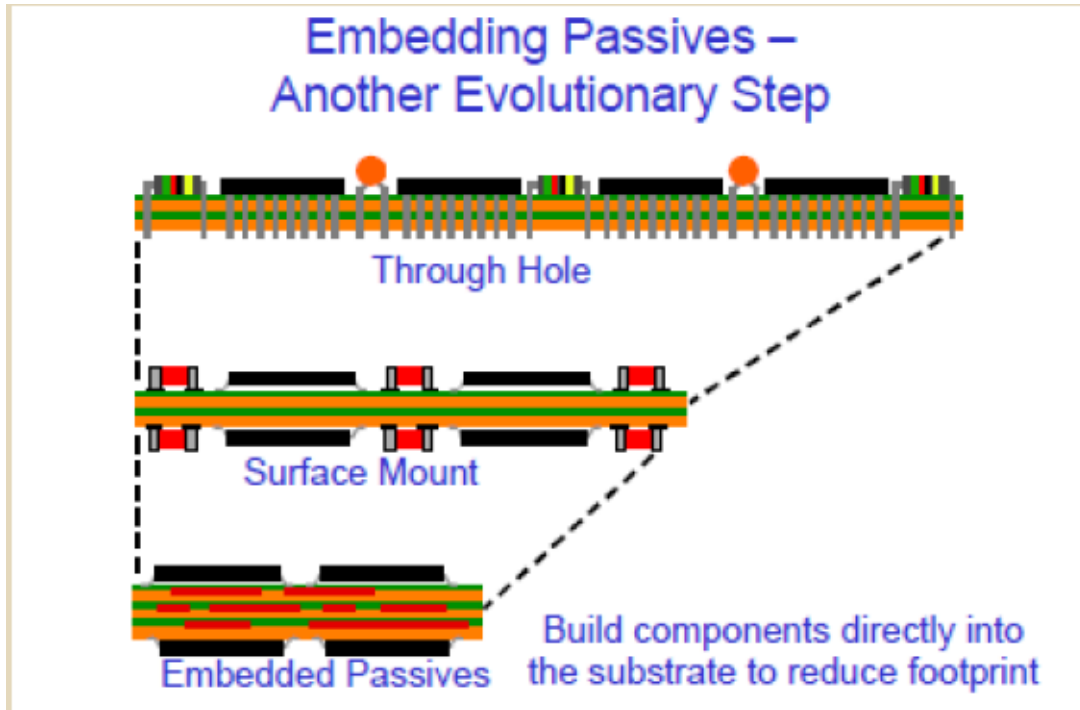

Figure 3 above shows the evolution of embedded passive components, starting with through hole parts on top then Surface Mount devices (SMD) and below that, Embedded Passive components. These are symbolized as the red horizontal lines. Note that this technology does not allow for embedding the active components which still remain on top of the PCB. This leaves the PCB vulnerable to external high frequency interference (RFI and EMP).

From Evolution to Revolution: Mulpin Components

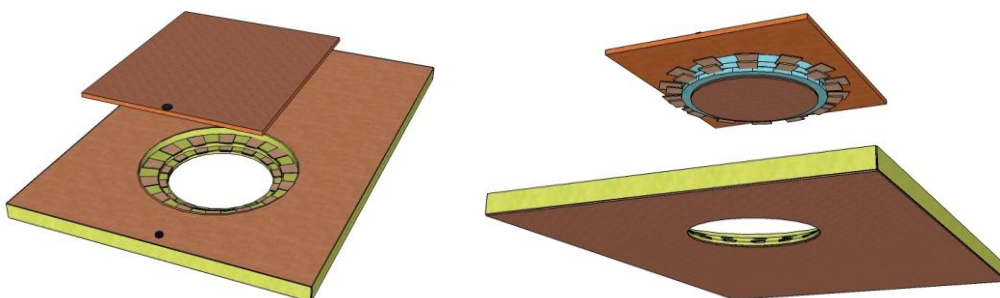

Figure 4. Two views of a Multi layer Mulpin active component above (Integrated Circuit) before placing into the PCB. (The same principle applies to Mulpin embedded passives) Note that in this example the PCB opening for the component is complementary in shape to that of the connections of the integrated circuit.

Pictorial View of a Mulpin PCB with both active and passive Mulpin components

A passive component, a resistor with heat transfer top delivers excess heat to the PCB via its cover. Upper component shows cover off and the lower component has its cover fitted.

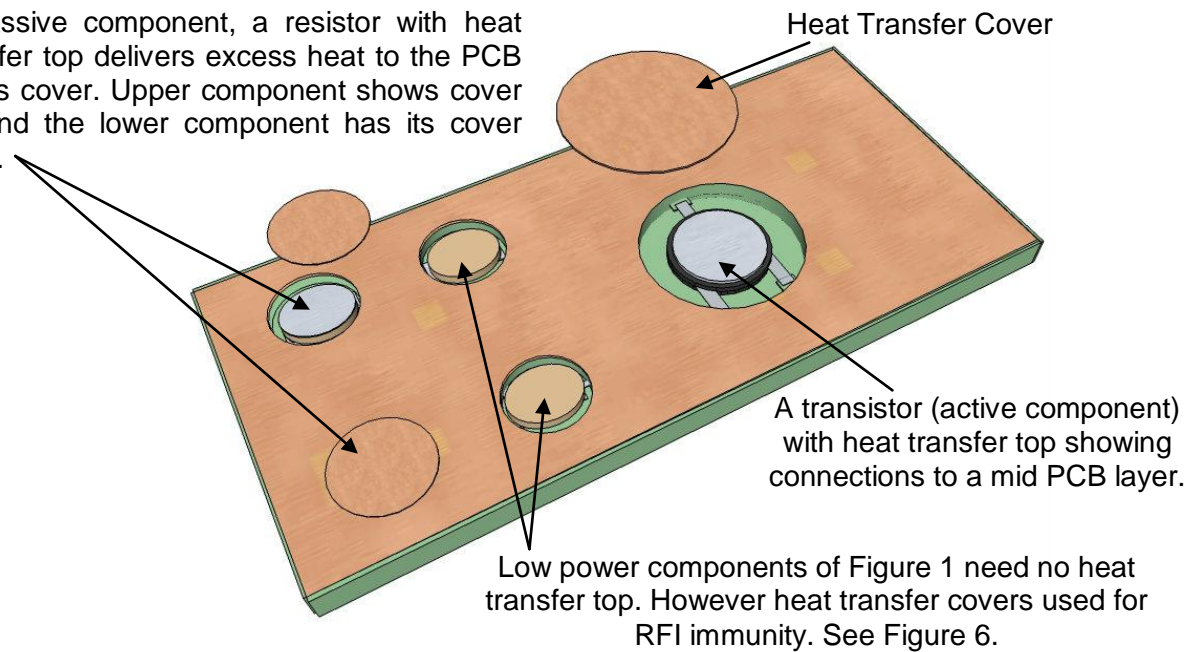

Figure 5 shows both passive and active Mulpin components embedded in a PCB through openings in the top of the PCB.

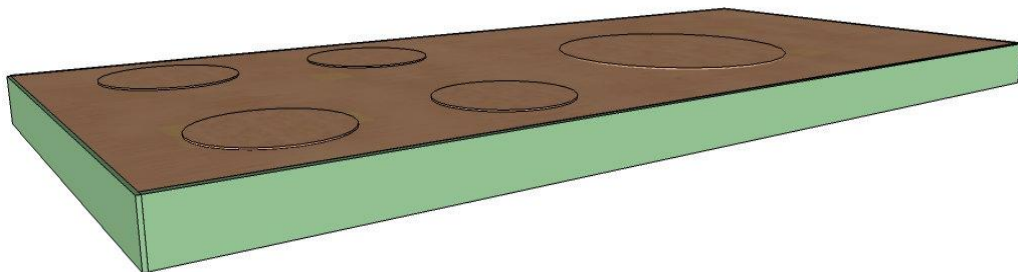

Figure 6 shows the same Mulpin PCB with all covers in place. This is what gives Mulpin components their water proof dust proof, vibration proof and immunity to RFI an even EMP.

PICTORIAL VIEW OF A CURRENT PCB USING EMBEDDED PASSIVE COMPONENTS

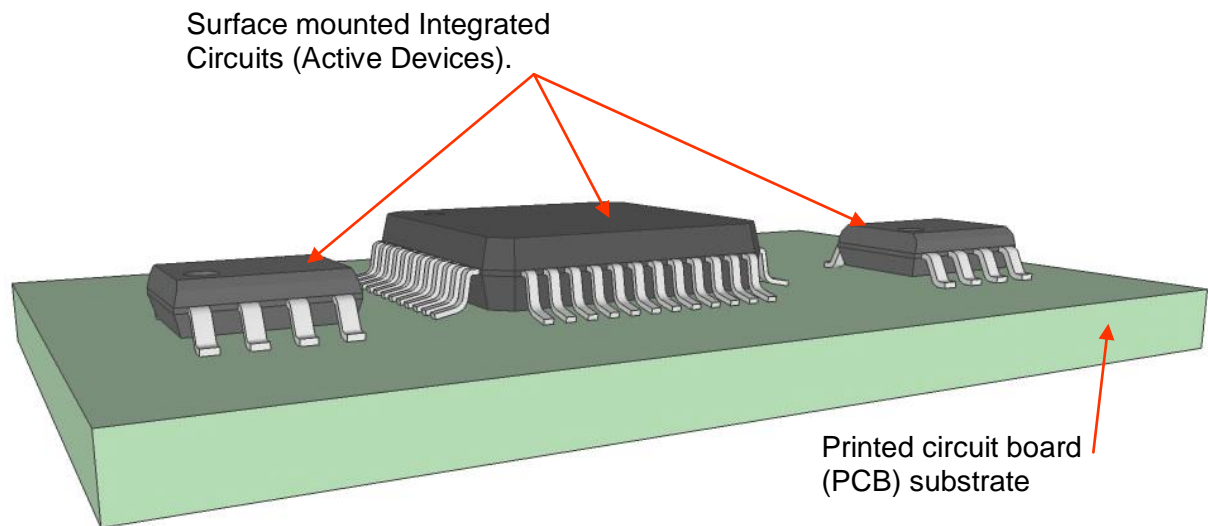

Figure 7 shows a non Mulpin PCB with the active components on the top. The embedded passive components within the substrate of the PCB cannot be seen in this picture. See Figure 8.

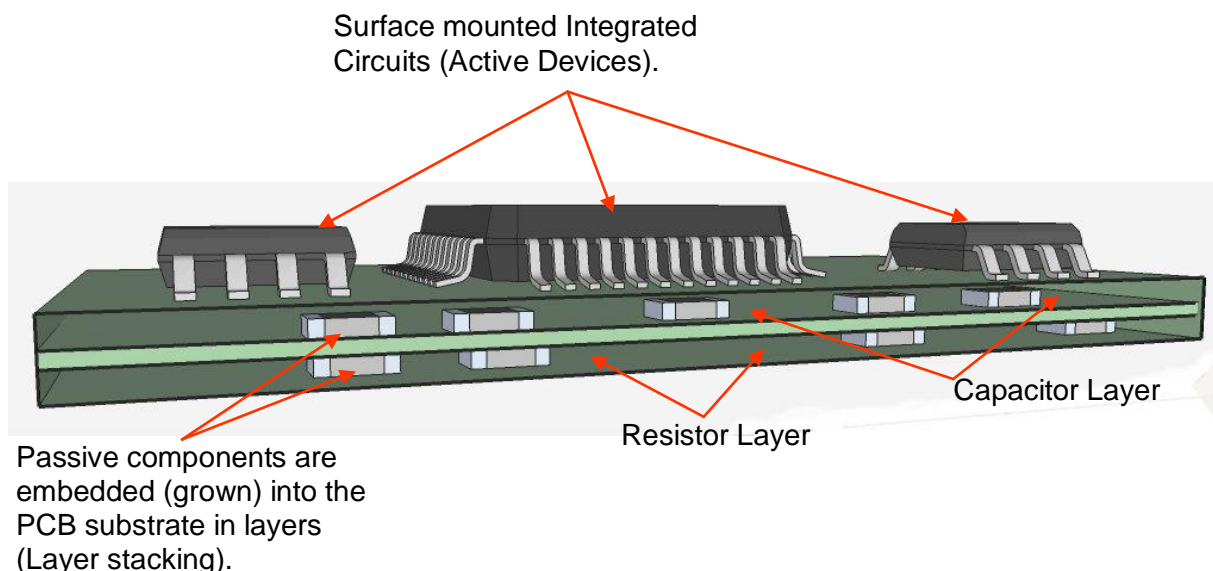

Figure 8 is a cutaway view of the same PCB, showing the embedded passive components (non Mulpin). Note that the resistors are on a separate layer to the capacitors. This is called Layer Stacking and is required because the resistors require a different manufacturing (growing) process than do the capacitors. The active devices are all by necessity mounted on top of the PCB. This seriously negates the perceived advantage that the passive components being embedded reduce the vulnerability to RFI and EMI, let alone EMP. Mulpin components are far superior in that regard. (see "proof of Concept" video exposing a Mulpin PCB to one million volts from a Tesla Coil and 800 watts from a Microwave oven). www.mulpin.com

SUMMARY OF EMBEDDED PASSIVES

It is important to note that non- Mulpin Embedded Passives are not widely used throughout the industry because of the unreliability and high cost of the technology which is illustrated in the link articles below; however within the military and aerospace industry embedded technology has been employed with the use of ceramic material which comes at very high cost. Ceramics are used to eliminate cracking due to expansion and contraction problems with conventional materials.

The advantages of Mulpin Technology include its low cost and its simplicity and its similarity to the proven long term reliability of SMD components, thus giving industry confidence in its use. As shown in the documentation above, Mulpin Technology is the next generation of both passive and active component technology. The electronics industry has been calling out for all components to be embedded for decades. Mulpin has arrived with entirely practical solutions to all of the problems encountered with all other technologies including current embedded technology. E.g. smaller PCBs with better heat removal, Water, Dust, vibration, RFI, EMI and EMP proofing. Mulpin holds the future to increased reliability and board longevity which results in improved safety particularly in medical applications / devices.

Embedded Passives in Device Packaging: What is Limiting Widespread Adoption?

<http://www.electroiq.com/articles/ap/print/volume-17/issue-10/departments/editorialboard/embedded-passives-in-device-packaging-what-is-limiting-widespread-adoption.html>

(Click link above to view paragraph extracts below)

Furthermore, when various elements are placed in close proximity, their fields may interact with each other and need further model refinement to fully predict performance. The learning curve may lead to lower yields in initial implementation attempts may discourage broader implementation. (Paragraph 5)

Embedded passives have been the norm when you look at what is going on defense and aerospace. Here, the performance gains achieved are key and ceramics materials are the standard materials of choice typically processed in panels barely larger than the size of today's semiconductor wafers. Design libraries have been developed by some of the individual players in these segments but are not broadly available and in some cases, maybe even classified. Even where the information is publicly available, the solutions are often too expensive for application in the commercial sector. (Paragraph 6)

EXPERIMENTAL RELIABILITY ASSESSMENT

https://smartech.gatech.edu/bitstream/handle/1853/7643/lee_kang_j...?sequence=1

(Click link above to view paragraph extract below)

Although embedded passives present better reliability with the elimination of solder joint interconnects, the embedded passives also introduce other concerns such as cracks, delamination and component instability. More substrate layers will be needed to accommodate the embedded passives, and various CTE materials within the substrate may cause significant thermo-mechanical stress due to CTE mismatch. Unlike surface mounted components where defective parts can be reworked and replaced, a single bad component can obliterate the entire board. Consequently, reliability is a major issue in the acceptance and success of embedded passives technology. (Page 84)

A SELECTION OF Mulpin COMPONENTS

Figure 9: 50% Smaller Component

Figure 9, below shows a standard MSOP8 IC package (bordered in red) from a mobile phone. Outside of red border shows an equivalent Mulpin component MSOR8 IC package to the same scale. It is half the size and is capable of higher power (heat) dissipation than the MSOP8. The MSOP8 which is already a very small component being 2.9mm x 4.75mm. The Mulpin part measures 1.5mm x 2.4mm.

All measurements are shown in millimeters

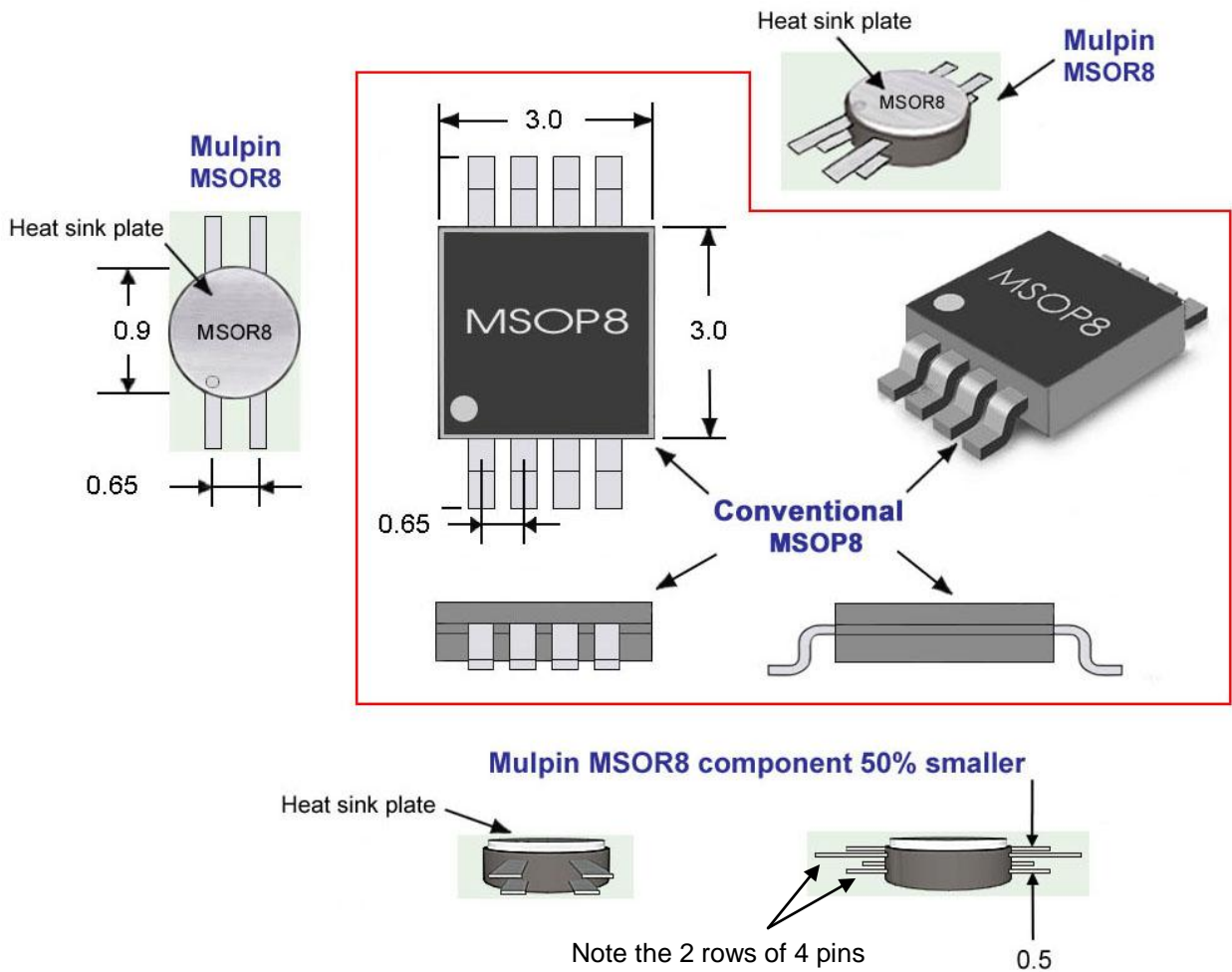

There are many other Mulpin Components not shown in this document. However figure 10 below shows a dual use component expanded many times normal size. Firstly it can be fitted on the top of a PCB as an SMD component which allows the component to be monitored for development purposes. It could be left as an SMD component. Alternatively, after the research is completed, the production version of the PCB can have the component embedded as a Mulpin Component to bring all of the additional benefits that Mulpin Components have to offer.



Figure 10. Two views of an active Mulpin eight pin Component (Integrated Circuit) which is a dual usage component. See text for details.

Mulpin 4 Layer PCB

